

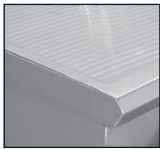

Model IDBS-36



Corrugated drainboard and polished bullnose

**PROJECT:** \_\_\_\_\_

**ITEM NUMBER:** \_\_\_\_\_ **QTY:** \_\_\_\_\_

## DRAINBOARDS

### MODELS

#### 'S' SERIES 20-1/2" DEEP

- |                                  |                                  |                                  |
|----------------------------------|----------------------------------|----------------------------------|
| <input type="checkbox"/> IDBS-12 | <input type="checkbox"/> IDBS-36 | <input type="checkbox"/> IDBS-60 |
| <input type="checkbox"/> IDBS-18 | <input type="checkbox"/> IDBS-42 | <input type="checkbox"/> IDBS-66 |
| <input type="checkbox"/> IDBS-24 | <input type="checkbox"/> IDBS-48 | <input type="checkbox"/> IDBS-72 |
| <input type="checkbox"/> IDBS-30 | <input type="checkbox"/> IDBS-54 |                                  |

#### 'D' SERIES 24" DEEP

- |                                  |                                  |                                  |
|----------------------------------|----------------------------------|----------------------------------|
| <input type="checkbox"/> IDBD-12 | <input type="checkbox"/> IDBD-36 | <input type="checkbox"/> IDBD-60 |
| <input type="checkbox"/> IDBD-18 | <input type="checkbox"/> IDBD-42 | <input type="checkbox"/> IDBD-66 |
| <input type="checkbox"/> IDBD-24 | <input type="checkbox"/> IDBD-48 | <input type="checkbox"/> IDBD-72 |
| <input type="checkbox"/> IDBD-30 | <input type="checkbox"/> IDBD-54 |                                  |

### STANDARD FEATURES

- All Heliarc welded construction
- All 18-Gauge, Type 304 stainless steel
- Attractive high polished bullnose edge-to-front
- 1-5/8" stainless steel 16-gauge legs with 1" stainless steel cross bracing
- Adjustable stainless steel bullet feet
- Heavy duty stainless steel gussets welded to 14-Gauge stainless steel channel supports
- Drainboard top has continuous corrugation
- Drainboards are recessed and pitch to a 1" brass drain

### OPTIONS

- |                                      |   |
|--------------------------------------|---|
| <input type="checkbox"/> <b>BLN6</b> | 6" Beverage (liquor line) Notch in Splash |
| <input type="checkbox"/> <b>BO</b>   | Bottle Opener with Catch Pan              |
| <input type="checkbox"/> <b>CA</b>   | Cut Away Apron for Trash Can              |
| <input type="checkbox"/> <b>LSS</b>  | Left Side Splash                          |
| <input type="checkbox"/> <b>PT</b>   | Plain Flat Top                            |
| <input type="checkbox"/> <b>RSS</b>  | Right Side Splash                         |
| <input type="checkbox"/> <b>RD</b>   | Recessed Drainboard                       |
| <input type="checkbox"/> <b>RTC</b>  | Rubber Trash Chute in Front Apron         |
| <input type="checkbox"/> <b>TC</b>   | Plastic Trash Can                         |
| <input type="checkbox"/> <b>TR</b>   | Towel Rail                                |
| <input type="checkbox"/> <b>USS</b>  | Undershelf 'S' Series                     |
| <input type="checkbox"/> <b>USD</b>  | Undershelf 'D' Series                     |
| <input type="checkbox"/> <b>M</b>    | Modified - Custom                         |



### INFINITY KITCHEN PRODUCTS, INC.

7750 Scout Ave. • Bell Gardens, CA 90201  
 Toll Free: (866) 349-0005 • Ph: (562) 806-5771 • Fax: (562) 806-6771  
 infinitystainless.com • customerservice@infinitystainless.com

Proudly Made in America

# DRAINBOARDS

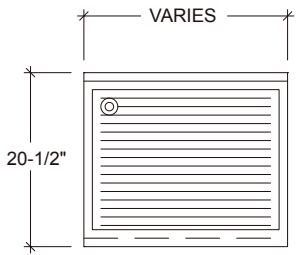

**'S' SERIES PLAN VIEW**

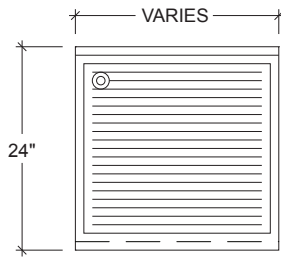

**'D' SERIES PLAN VIEW**

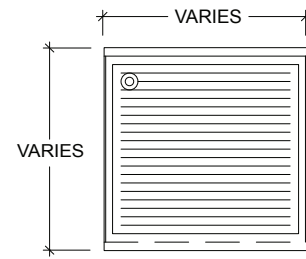

**'S' or 'D' SERIES RECESSED PLAN VIEW**

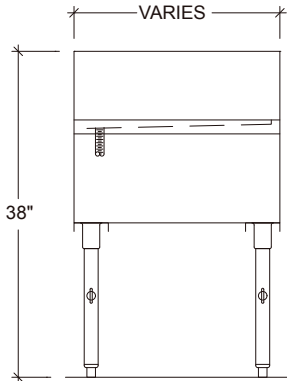

**'S' SERIES ELEVATION**

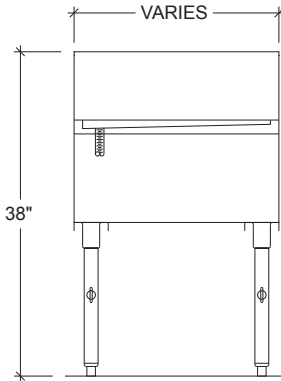

**'D' SERIES ELEVATION**

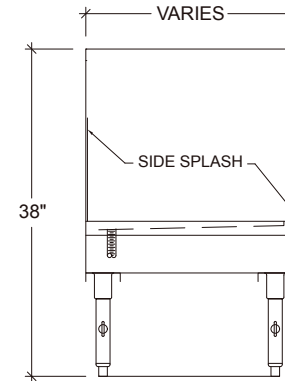

**'S' or 'D' SERIES RECESSED ELEVATION**

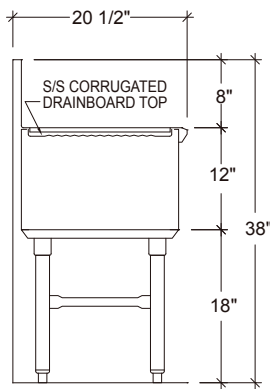

**'S' SERIES SECTION**

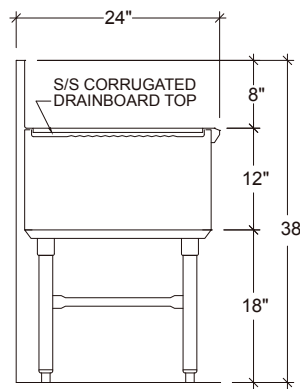

**'D' SERIES SECTION**

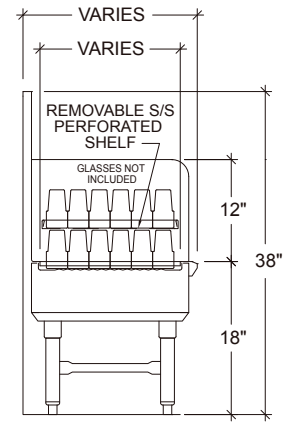

**'S' or 'D' SERIES RECESSED SECTION**

<b>'S' SERIES 20-1/2" DEEP</b>		
MODEL NO.	LENGTH	WEIGHT
IDBS-12	12"	45
IDBS-18	18"	55
IDBS-24	24"	60
IDBS-30	30"	65
IDBS-36	36"	75
IDBS-42	42"	95
IDBS-48	48"	120
IDBS-54	54"	135
IDBS-60	60"	150
IDBS-66	66"	165
IDBS-72	72"	175

<b>'D' SERIES 24" DEEP</b>		
MODEL NO.	LENGTH	WEIGHT
IDBD-12	12"	45
IDBD-18	18"	55
IDBD-24	24"	60
IDBD-30	30"	65
IDBD-36	36"	75
IDBD-42	42"	95
IDBD-48	48"	120
IDBD-54	54"	135
IDBD-60	60"	150
IDBD-66	66"	165
IDBD-72	72"	175

<b>'S' SERIES RECESSED 20-1/2" DEEP</b>		
MODEL NO.	LENGTH	WEIGHT
IDBS-12-RD	12"	45
IDBS-18-RD	18"	55
IDBS-24-RD	24"	60
IDBS-30-RD	30"	65
IDBS-36-RD	36"	75

<b>'D' SERIES RECESSED 24" DEEP</b>		
MODEL NO.	LENGTH	WEIGHT
IDBD-12-RD	12"	45
IDBD-18-RD	18"	55
IDBD-24-RD	24"	60
IDBD-30-RD	30"	65
IDBD-36-RD	36"	75

<b>UTILITIES</b>
BRASS DRAIN
1 X 1"

## INFINITY KITCHEN PRODUCTS, INC.

7750 Scout Ave. • Bell Gardens, CA 90201  
 Toll Free: (866) 349-0005 • Ph: (562) 806-5771 • Fax: (562) 806-6771  
 infinitystainless.com • customerservice@infinitystainless.com

*Proudly Made  
in America*